

Solid State Contactors (Three-phase) G3PB

Space and working time saved with new heat sink construction. Series now includes 480-VAC models to allow use in a greater range of applications.

- A comprehensive lineup that now includes 480-VAC models.
- Slim design with 3-phase output and built-in heat sinks.
- New heat sink construction with smaller mounting section.
- DIN track mounting supported as standard. (Screw mounting is also possible.)
- Certified by UL, CSA, and VDE.



Model Number Structure

■ Model Number Legend

G3PB-□□□-□□-□
 1 2 3 4 5 6 7

1. Basic Model Name

G3PB: Solid State Relay

2. Rated Load Power Supply Voltage

2: 200 VAC

5: 480 VAC

3. Rated Load Current

15: 15 A

25: 25 A

35: 35 A

45: 45 A

4. Terminal Type

B: Screw terminals

5. Single-phase/3-phase and Number of Elements for 3-phase

2: 3-phase, 2-element models

3: 3-phase, 3-element models

6. 3-phase Type

N: DIN track mounting and built-in heat sink

7. Certification

VD: Certified by UL, CSA, and VDE

Ordering Information

■ List of Models (Built-in Heat Sinks)

Applicable phase	Main circuit voltage	Zero cross function	Applicable heater capacity (with Class-1 AC resistive load)	Number of poles	Model
3	100 to 240 VAC	Yes	5.1 kW max. (15 A)	3	G3PB-215B-3N-VD
				2	G3PB-215B-2N-VD
			8.6 kW max. (25 A)	3	G3PB-225B-3N-VD
				2	G3PB-225B-2N-VD
			12.1 kW max. (35 A)	3	G3PB-235B-3N-VD
				2	G3PB-235B-2N-VD
	15.5 kW max. (45 A)		3	G3PB-245B-3N-VD	
			2	G3PB-245B-2N-VD	
	200 to 480 VAC		12.5 kW max. (15 A)	3	G3PB-515B-3N-VD
				2	G3PB-515B-2N-VD
			20.7 kW max. (25 A)	3	G3PB-525B-3N-VD
				2	G3PB-525B-2N-VD
			29.0 kW max. (35 A)	3	G3PB-535B-3N-VD
				2	G3PB-535B-2N-VD
37.4 kW max. (45 A)		3	G3PB-545B-3N-VD		
		2	G3PB-545B-2N-VD		

Note: When ordering, specify the rated input voltage.

Specifications

■ Ratings (at an Ambient Temperature of 25°C)

Operating Circuit (Common)

Item	Common
Rated voltage	12 to 24 VDC
Operating voltage range	9.6 to 30 VDC
Rated input current (Impedance)	10 mA max. (at 24 VDC)
Must operate voltage	9.6 VDC max.
Must release voltage	1 VDC min.
Insulation method	Phototriac coupler
Operation indicator	Yellow LED

Main Circuit of Models with Built-in Heat Sinks

Item	G3PB-215B-3N-VD	G3PB-215B-2N-VD	G3PB-225B-3N-VD	G3PB-225B-2N-VD	G3PB-235B-3N-VD	G3PB-235B-2N-VD	G3PB-245B-3N-VD	G3PB-245B-2N-VD
Rated load voltage	100 to 240 VAC							
Load voltage range	75 to 264 VAC							
Applicable load current (See note.)	0.2 to 15 A		0.2 to 25 A		0.5 to 35 A		0.5 to 45 A	
Inrush current resistance (peak value)	150 A (60 Hz, 1 cycle)		220 A (60 Hz, 1 cycle)		440 A (60 Hz, 1 cycle)			
Permissible I ² t (half 60-Hz wave)	260 A ² s		2,660 A ² s		2,660 A ² s			

Item	G3PB-515B-3N-VD	G3PB-515B-2N-VD	G3PB-525B-3N-VD	G3PB-525B-2N-VD	G3PB-535B-3N-VD	G3PB-535B-2N-VD	G3PB-545B-3N-VD	G3PB-545B-2N-VD
Rated load voltage	200 to 480 VAC							
Load voltage range	180 to 528 VAC							
Applicable load current (See note.)	0.5 to 15 A		0.5 to 25 A		0.5 to 35 A		0.5 to 45 A	
Inrush current resistance (peak value)	220 A (60 Hz, 1 cycle)				440 A (60 Hz, 1 cycle)			
Permissible I ² t (half 60-Hz wave)	260 A ² s		1,040 A ² s		1,040 A ² s			

Note: Applicable load current varies depending on the ambient temperature. For details, refer to *Load Current vs. Ambient Temperature* in *Engineering Data*.

■ Characteristics

Models with Built-in Heat Sinks

Item	G3PB-215B-3N-VD	G3PB-215B-2N-VD	G3PB-225B-3N-VD	G3PB-225B-2N-VD	G3PB-235B-3N-VD	G3PB-235B-2N-VD	G3PB-245B-3N-VD	G3PB-245B-2N-VD
Operate time	1/2 of load power source cycle + 1 ms max. (DC input)							
Release time	1/2 of load power source cycle + 1 ms max. (DC input)							
Output ON voltage drop	1.6 V (RMS) max.							
Leakage current (See note.)	10 mA (at 200 VAC)							
Insulation resistance	100 M Ω min. (at 500 VDC)							
Dielectric strength	2,500 VAC, 50/60 Hz for 1 min							
Vibration resistance	Destruction: 10 to 55 to 10 Hz, 0.175-mm single amplitude (Mounted to DIN track)							
Shock resistance	Destruction: 294 m/s ² (98 m/s ² with reverse mounting)							
Ambient temperature	Operating: -30°C to 80°C (with no icing or condensation) Storage: -30°C to 100°C (with no icing or condensation)							
Ambient humidity	Operating: 45% to 85%							
Weight	Approx. 1.25 kg		Approx. 1.45 kg		Approx. 1.65 kg		Approx. 2.0 kg	
Certified standards	UL508, CSA22.2 No. 14, EN60947-4-3 (IEC947-4-3); Certified by VDE (From April 2001)							
EMC	Emission		EN55011 Group 1 Class B					
	Immunity	ESD	IEC947-4-3, EN61000-4-2 4 kV contact discharge 8 kV air discharge					
	Immunity	Electromagnetic	IEC947-4-3, EN61000-4-3 10 V/m (80 MHz to 1 GHz)					
	Immunity	EFT	IEC947-4-3, EN61000-4-4 2 kV AC power-signal line					
	Immunity	Surge transient	IEC947-4-3, EN61000-4-5 Normal mode ± 1 kV, Common mode ± 2 kV					
	Immunity	RF disturbance	IEC947-4-3, EN61000-4-6 10 V (0.15 to 80 MHz)					
	Immunity	Dips	IEC947-4-3, EN61000-4-11					

Note: The leakage current of phase S will be approximately $\sqrt{3}$ times larger if the 2-element model is applied.

Item	G3PB-515B-3N-VD	G3PB-515B-2N-VD	G3PB-525B-3N-VD	G3PB-525B-2N-VD	G3PB-535B-3N-VD	G3PB-535B-2N-VD	G3PB-545B-3N-VD	G3PB-545B-2N-VD
Operate time	1/2 of load power source cycle + 1 ms max. (DC input)							
Release time	1/2 of load power source cycle + 1 ms max. (DC input)							
Output ON voltage drop	1.8 V (RMS) max.							
Leakage current (See note.)	20 mA (at 480 VAC)							
Insulation resistance	100 MΩ min. (at 500 VDC)							
Dielectric strength	2,500 VAC, 50/60 Hz for 1 min							
Vibration resistance	Destruction: 10 to 55 to 10 Hz, 0.175-mm single amplitude (Mounted to DIN track)							
Shock resistance	Destruction: 294 m/s ² (98 m/s ² with reverse mounting)							
Ambient temperature	Operating: -30°C to 80°C (with no icing or condensation) Storage: -30°C to 100°C (with no icing or condensation)							
Ambient humidity	Operating: 45% to 85%							
Weight	Approx. 1.25 kg		Approx. 1.45 kg		Approx. 1.65 kg		Approx. 2.0 kg	
Certified standards	UL508, CSA22.2 No. 14, EN60947-4-3 (IEC947-4-3); Certified by VDE (From April 2001)							
EMC	Emission		Immunity		ESD		EN55011 Group 1 Class B IEC947-4-3, EN61000-4-2 4 kV contact discharge 8 kV air discharge	
	Immunity		Electromagnetic		EFT		IEC947-4-3, EN61000-4-3 10 V/m (80 MHz to 1 GHz) IEC947-4-3, EN61000-4-4 2 kV AC power-signal line	
	Immunity		Surge transient		RF disturbance		IEC947-4-3, EN61000-4-5 Normal mode ±1 kV, Common mode ±2 kV IEC947-4-3, EN61000-4-6 10 V (0.15 to 80 MHz)	
	Immunity		Dips				IEC947-4-3, EN61000-4-11	

Note: The leakage current of phase S will be approximately $\sqrt{3}$ times larger if the 2-element model is applied.

SSR

Engineering Data

Load Current vs. Ambient Temperature

Models with Built-in Heat Sinks

G3PB-215B-3N-VD	G3PB-225B-3N-VD	G3PB-235B-3N-VD	G3PB-245B-3N-VD
G3PB-215B-2N-VD	G3PB-225B-2N-VD	G3PB-235B-2N-VD	G3PB-245B-2N-VD
G3PB-515B-3N-VD	G3PB-525B-3N-VD	G3PB-535B-3N-VD	G3PB-545B-3N-VD
G3PB-515B-2N-VD	G3PB-525B-2N-VD	G3PB-535B-2N-VD	G3PB-545B-2N-VD

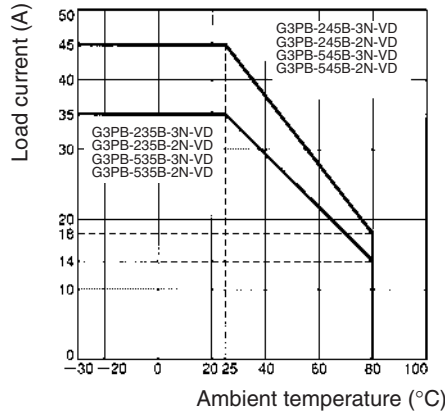
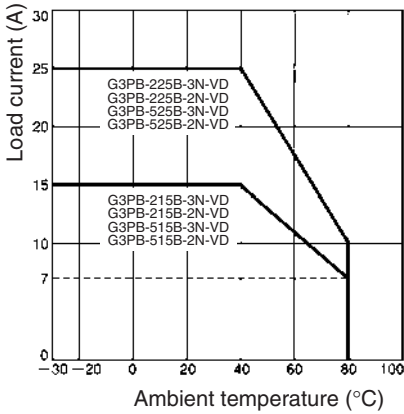

Input Voltage vs. Input Current and Input Voltage vs. Input Impedance

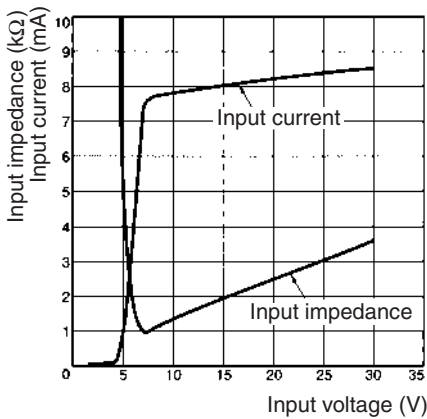

One Cycle Surge Current: Non-repetitive

Note: Keep the inrush current to half the rated value if it occurs repetitively.

G3PB-215B-3N-VD
G3PB-215B-2N-VD

G3PB-225B-3N-VD G3PB-225B-2N-VD
G3PB-515B-3N-VD G3PB-515B-2N-VD
G3PB-525B-3N-VD G3PB-525B-2N-VD

G3PB-235B-3N-VD G3PB-245B-3N-VD
G3PB-235B-2N-VD G3PB-245B-2N-VD
G3PB-535B-3N-VD G3PB-545B-3N-VD
G3PB-535B-2N-VD G3PB-545B-2N-VD

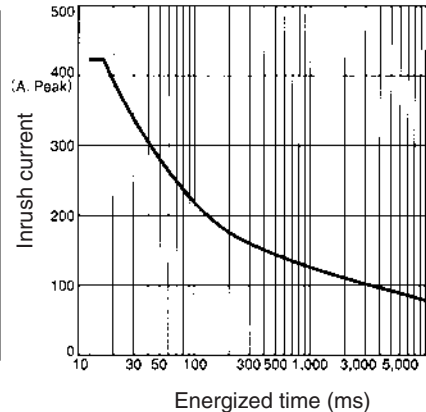
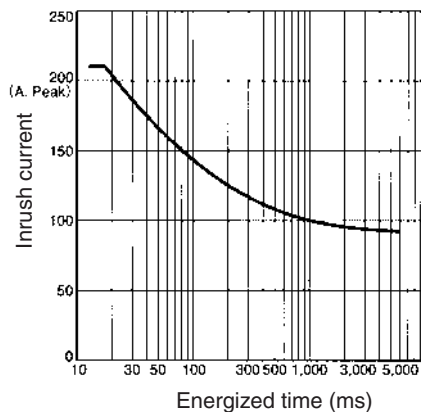
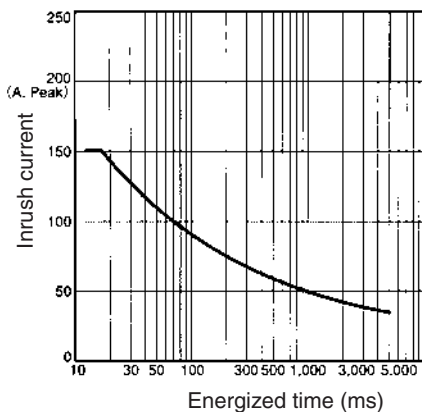

Dimensions

Note: All units are in millimeters unless otherwise indicated.

G3PB-215B-3N-VD G3PB-515B-3N-VD
 G3PB-215B-2N-VD G3PB-515B-2N-VD
 G3PB-225B-2N-VD G3PB-525B-2N-VD

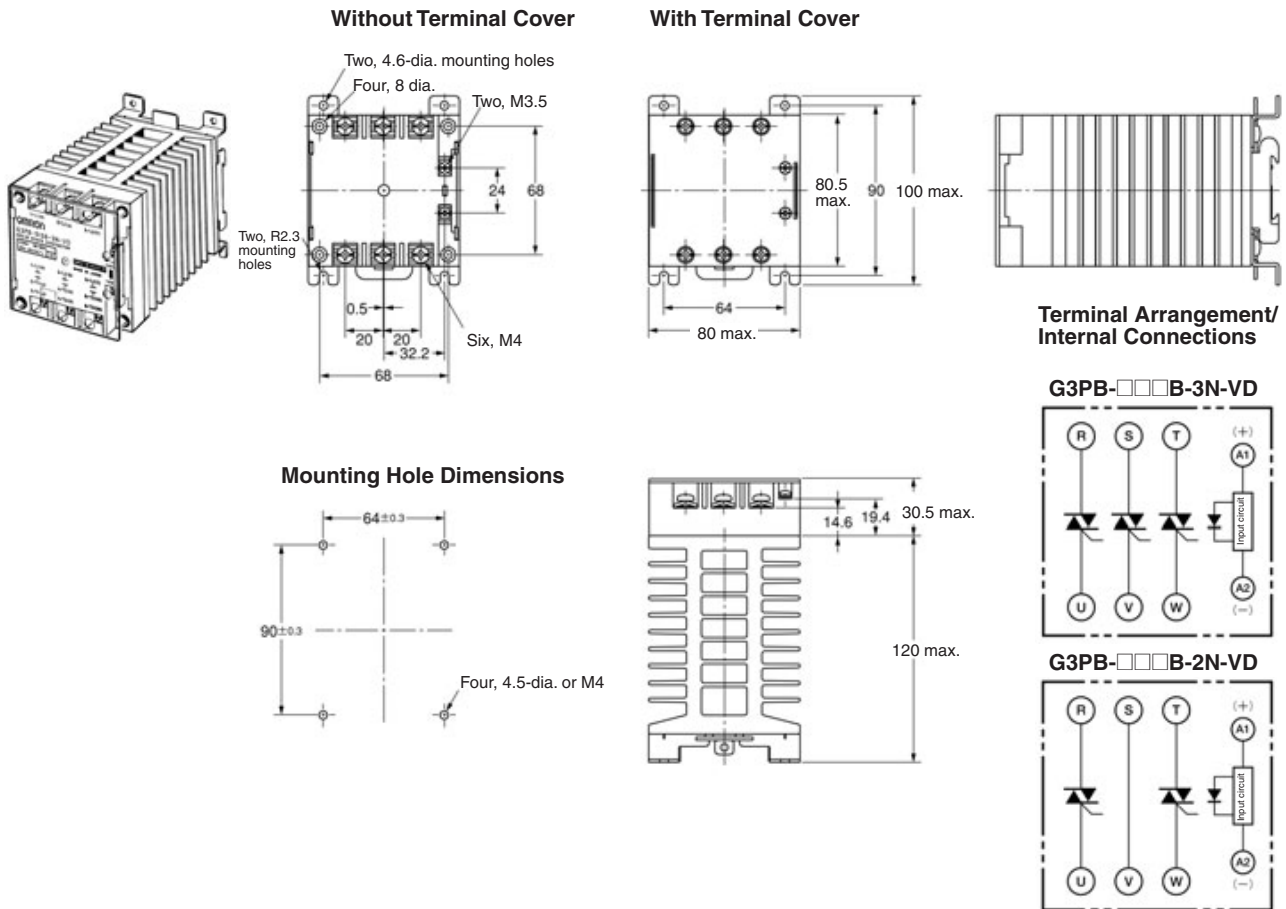

SSR

G3PB-225B-3N-VD
 G3PB-235B-2N-VD
 G3PB-525B-3N-VD
 G3PB-535B-2N-VD

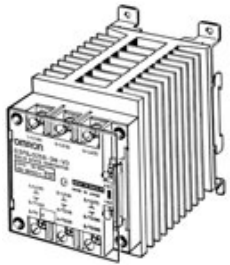

Without Terminal Cover

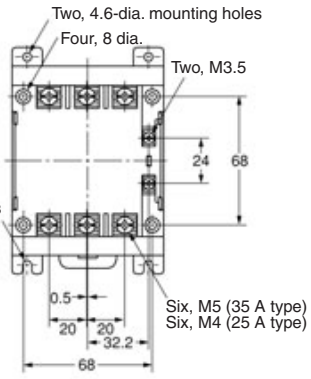

With Terminal Cover

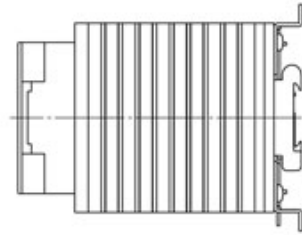
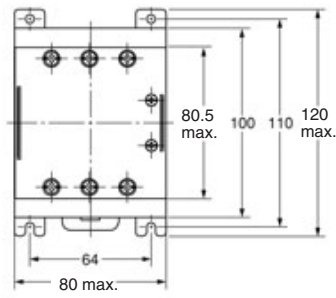

Mounting Hole Dimensions

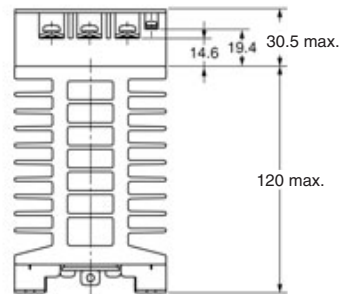
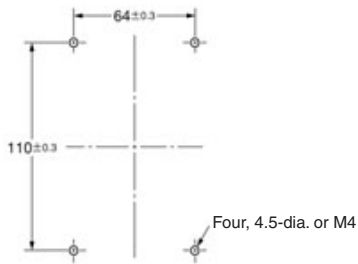

Terminal Arrangement/
Internal Connections

G3PB-□□□B-3N-VD

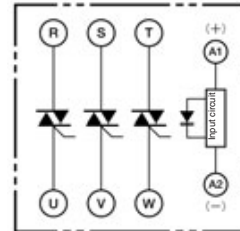

G3PB-□□□B-2N-VD

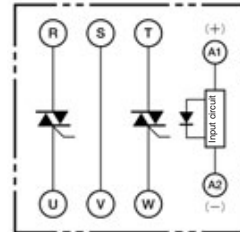

G3PB-235B-3N-VD
 G3PB-245B-2N-VD
 G3PB-535B-3N-VD
 G3PB-545B-2N-VD

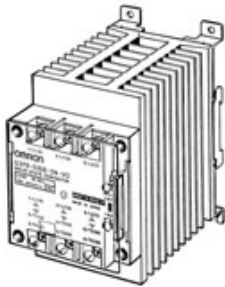

Without Terminal Cover

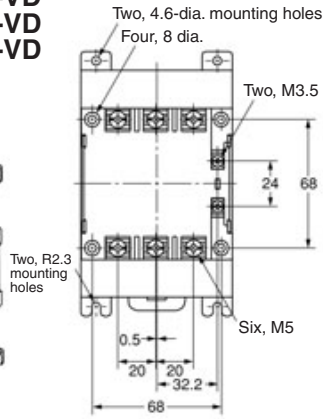

With Terminal Cover

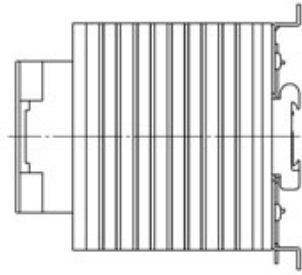
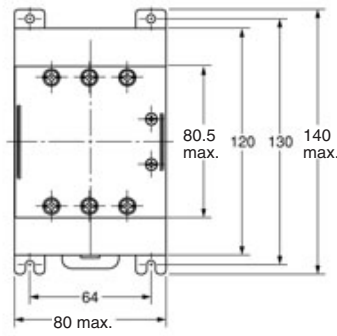

Terminal Arrangement/
Internal Connections

Mounting Hole Dimensions

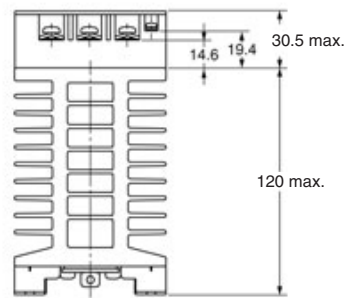
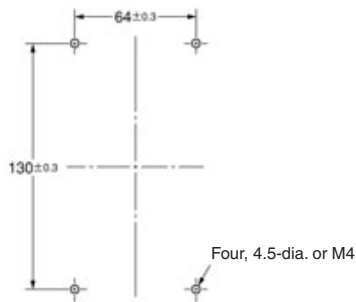

G3PB-□□□B-3N-VD

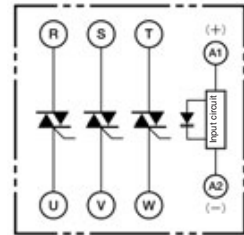

G3PB-□□□B-2N-VD

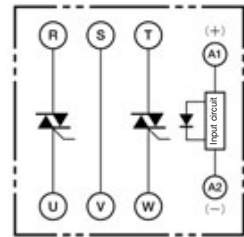

G3PB-245B-3N-VD
G3PB-545B-3N-VD

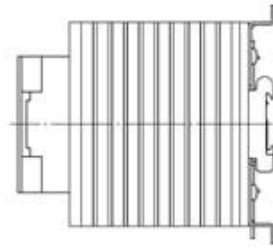
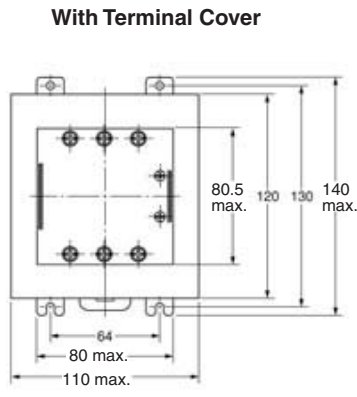
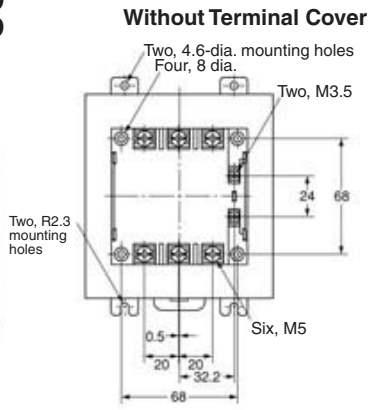
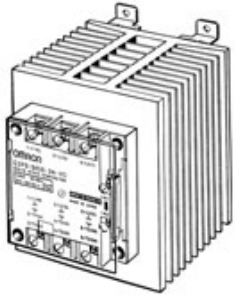

**Terminal Arrangement/
 Internal Connections**

G3PB-□□□B-3N-VD

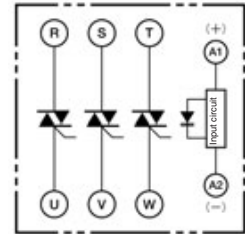

Mounting Hole Dimensions

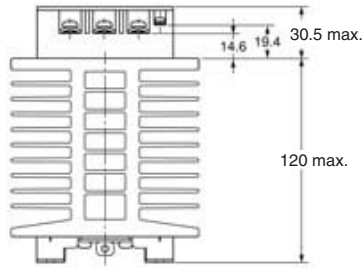
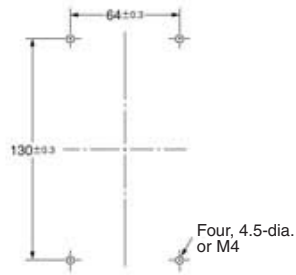

Safety Precautions

Precautions for Correct Use

Please observe the following precautions to prevent failure to operate, malfunction, or undesirable effect on product performance.

Mounting Method

Since the Relay is heavy, firmly mount the DIN track and fix both ends with End Plates for DIN-track-mounting models.

Applicable DIN Tracks

The G3PB can be mounted to TH35-15Fe (IEC60715) DIN tracks. The manufacturers and models of DIN tracks to which mounting is possible are shown in the following table.

Manufacturer	Thickness	
	1.5 mm	2.3 mm
Schneider	AM1-DE200	---
WAGO	210-114, 210-197	210-118
PHOENIX	NS35/15	NS35/15-2.3

Direct Mounting

When mounting directly onto a panel, mount securely under the following conditions.

Screw diameter: M4
Tightening torque: 0.98 to 1.47 N·m

Mounted State

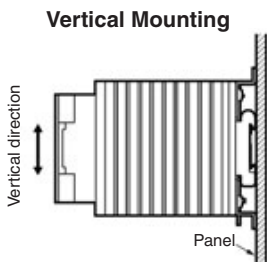

Note: Mount the G3PB so that the markings can be read.

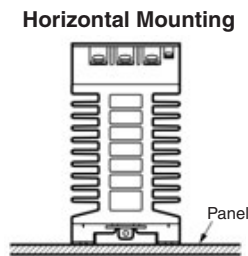

Note: When the G3PB is mounted horizontally, use at 50% of the rated load current.

Close Mounting

SSR Mounting Pitch

Panel Mounting

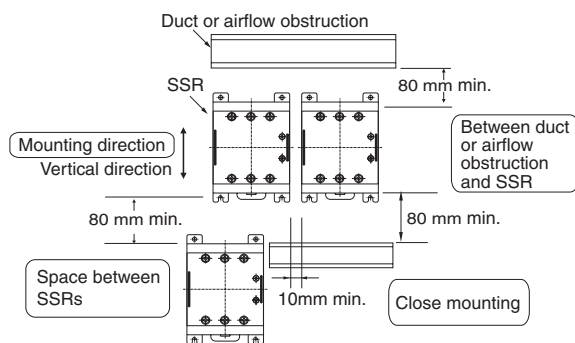

Relationship between SSRs and Ducts

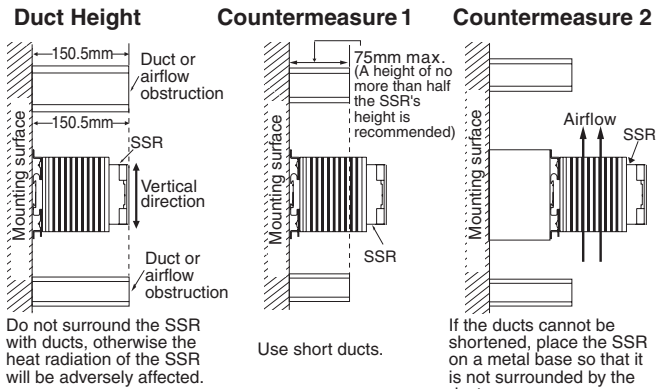

Ventilation

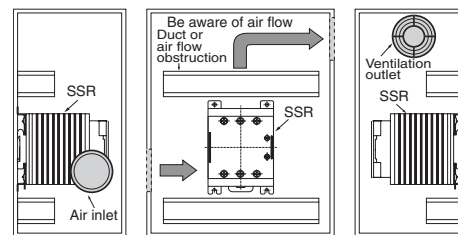

If the air inlet or air outlet has a filter, clean the filter regularly to prevent it from clogging and ensure an efficient flow of air.

Do not locate any objects around the air inlet or air outlet, otherwise the objects may obstruct the proper ventilation of the control panel.

A heat exchanger, if used, should be located in front of the SSR Units to ensure the efficiency of the heat exchanger.

Please reduce the ambient temperature of SSRs.

The rated load current of an SSR is measured at an ambient temperature of 25 or 40 °C.

An SSR uses a semiconductor in the output element. This causes the temperature inside the control panel to increase due to heating resulting from the passage of electrical current through the load. To restrict heating, attach a fan to the ventilation outlet or air inlet of the control panel to ventilate the panel. This will reduce the ambient temperature of the SSRs and thus increase reliability. (Generally, each 10 °C reduction in temperature will double the expected life.)

Three-element Devices

Load current (A)	15 A	25 A	35 A	45 A
Required number of fans per SSR	0.70	1.06	1.63	2.09

Two-element Devices

Load current (A)	15 A	25 A	35 A	45 A
Required number of fans per SSR	0.47	0.78	1.09	1.40

Example: For 10 SSRs with load currents of 11 A (3-element devices),
 $1.63 \times 10 = 16.3$
 Thus, 17 fans would be required.

Size of fans: 92 mm², Air volume: 0.7 m³/min,
 Ambient temperature of control panel: 30 °C

If there are other instruments that generate heat in the control panel other than SSRs, additional ventilation will be required.

SSR

Wiring

When using crimp terminals, refer to the terminal clearances shown below.

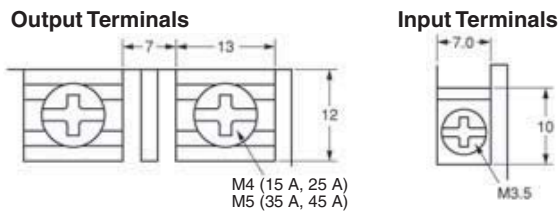

- Make sure that all lead wires are thick enough for the current.
- Output terminals T1, T2, and T3 are charged regardless of whether the Unit is a 2- or 3-element model that is turned on or off. Do not touch these terminals, otherwise an electric shock may be received.

To isolate the Unit from the power supply, install an appropriate circuit breaker between the power supply and Unit.

Be sure to turn off the power supply before wiring the Unit.

- Terminal L2 and terminal T2 of the 2-element model are internally short-circuited to each other. Therefore, connect terminal L2 to the ground terminal side of the power supply. If terminal L2 is connected to a terminal other than the ground terminal, cover all the charged terminals, such as heater terminals, for the prevention of electric shock accidents and ground faults.

Tightening Torque

Refer to the following and be sure to tighten each screw of the Unit to the specified torque in order to prevent the Unit from malfunctioning.

Item	Screw terminal diameter	Tightening torque
Input terminal	M3.5	0.59 to 1.18 N·m
Output terminal	M4	0.98 to 1.47 N·m
	M5	1.47 to 2.45 N·m

ALL DIMENSIONS SHOWN ARE IN MILLIMETERS.
 To convert millimeters into inches, multiply by 0.03937. To convert grams into ounces, multiply by 0.03527.