

Guard Lock Safety-door Switch

D4GL

Environment-friendly Switch with Direct Opening Contacts

- Contains no harmful substances, such as lead or cadmium, reducing the burden on the environment.
- Slim safety-door switch with an electromagnetic lock or unlock mechanism.
- Models with 4-contact and 5-contact built-in switches are available.
- Capable of a holding force of 1,000 N min.
- Can be used for either standard loads or microloads.
- Lineup includes models with a conduit size of M20.
- Patent and industrial design approval pending.



Model Number Structure

Model Number Legend

Switch

D4GL-□□□□-□□
 1 2 3 4 5 6

1. Conduit Size

- 1: Pg13.5
- 2: G1/2
- 4: M20

2. Built-in Switch (with Door Open/Closed Detection Switch and Lock Monitor Switch Contacts)

- A: 1NC/1NO slow-action contacts plus 1NC/1NO slow-action contacts
- B: 1NC/1NO slow-action contacts plus 2NC slow-action contacts
- C: 2NC slow-action contacts plus 1NC/1NO slow-action contacts
- D: 2NC slow-action contacts plus 2NC slow-action contacts
- E: 2NC/1NO slow-action contacts plus 1NC/1NO slow-action contacts
- F: 2NC/1NO slow-action contacts plus 2NC slow-action contacts
- G: 3NC slow-action contacts plus 1NC/1NO slow-action contacts
- H: 3NC slow-action contacts plus 2NC slow-action contacts

3. Head Mounting Direction and Material

- F: Four mounting directions possible (Front-side mounting at time of delivery)/plastic

4. Door Lock and Release

- A: Mechanical lock/24-VDC solenoid release
- G: 24-VDC solenoid lock/mechanical release

5. Indicator

- B: 24 VDC (orange/green LED indicator)

6. Release Key Type

- Blank: Standard release key
- 4: Special release key

Operation Key

D4DS-K□
 1

1. Operation Key Type

- 1: Horizontal mounting
- 2: Vertical mounting
- 3: Adjustable mounting (horizontal)
- 5: Adjustable mounting (horizontal/vertical)

Ordering Information

List of Models

Switches (Operation Keys are sold separately.)





■: Models with approved direct opening contacts.

Head material	Release key type	Solenoid voltage/indicator	Lock and release types	Contact configuration (door open/closed detection switch and lock monitor switch contacts) (slow-action) Approved direct opening NC contact	Conduit size	Model
Plastic	Standard	Solenoid: 24 VDC Orange/green LED: 24 VDC	Mechanical lock Solenoid release	1NC/1NO+1NC/1NO	Pg13.5	D4GL-1AFA-A
					G1/2	D4GL-2AFA-A
					M20	D4GL-4AFA-A
				1NC/1NO+2NC	Pg13.5	D4GL-1BFA-A
					G1/2	D4GL-2BFA-A
					M20	D4GL-4BFA-A
				2NC+1NC/1NO	Pg13.5	D4GL-1CFA-A
					G1/2	D4GL-2CFA-A
					M20	D4GL-4CFA-A
				2NC+2NC	Pg13.5	D4GL-1DFA-A
					G1/2	D4GL-2DFA-A
					M20	D4GL-4DFA-A
				2NC/1NO+1NC/1NO	Pg13.5	D4GL-1EFA-A
					G1/2	D4GL-2EFA-A
					M20	D4GL-4EFA-A
				2NC/1NO+2NC	Pg13.5	D4GL-1FFA-A
					G1/2	D4GL-2FFA-A
					M20	D4GL-4FFA-A
			3NC+1NC/1NO	Pg13.5	D4GL-1GFA-A	
				G1/2	D4GL-2GFA-A	
				M20	D4GL-4GFA-A	
			3NC+2NC	Pg13.5	D4GL-1HFA-A	
				G1/2	D4GL-2HFA-A	
				M20	D4GL-4HFA-A	
			Solenoid lock Mechanical release	1NC/1NO+1NC/1NO	Pg13.5	D4GL-1AFG-A
					G1/2	D4GL-2AFG-A
					M20	D4GL-4AFG-A
				1NC/1NO+2NC	Pg13.5	D4GL-1BFG-A
					G1/2	D4GL-2BFG-A
					M20	D4GL-4BFG-A
				2NC+1NC/1NO	Pg13.5	D4GL-1CFG-A
					G1/2	D4GL-2CFG-A
					M20	D4GL-4CFG-A
				2NC+2NC	Pg13.5	D4GL-1DFG-A
					G1/2	D4GL-2DFG-A
					M20	D4GL-4DFG-A
2NC/1NO+1NC/1NO	Pg13.5	D4GL-1EFG-A				
	G1/2	D4GL-2EFG-A				
	M20	D4GL-4EFG-A				
2NC/1NO+2NC	Pg13.5	D4GL-1FFG-A				
	G1/2	D4GL-2FFG-A				
	M20	D4GL-4FFG-A				
3NC+1NC/1NO	Pg13.5	D4GL-1GFG-A				
	G1/2	D4GL-2GFG-A				
	M20	D4GL-4GFG-A				
3NC+2NC	Pg13.5	D4GL-1HFG-A				
	G1/2	D4GL-2HFG-A				
	M20	D4GL-4HFG-A				

D4GL

Head material	Release key type	Solenoid voltage/indicator	Lock and release types	Contact configuration (door open/closed detection switch and lock monitor switch contacts) (slow-action) Approved direct opening NC contact	Conduit size	Model
Plastic	Special release key	Solenoid: 24 VDC Orange/green LED: 24 VDC	Mechanical lock Solenoid release	1NC/1NO+1NC/1NO	Pg13.5	D4GL-1AFA-A4
					G1/2	D4GL-2AFA-A4
					M20	D4GL-4AFA-A4
				1NC/1NO+2NC	Pg13.5	D4GL-1BFA-A4
					G1/2	D4GL-2BFA-A4
					M20	D4GL-4BFA-A4
				2NC+1NC/1NO	Pg13.5	D4GL-1CFA-A4
					G1/2	D4GL-2CFA-A4
					M20	D4GL-4CFA-A4
				2NC+2NC	Pg13.5	D4GL-1DFA-A4
					G1/2	D4GL-2DFA-A4
					M20	D4GL-4DFA-A4
				2NC/1NO+1NC/1NO	Pg13.5	D4GL-1EFA-A4
					G1/2	D4GL-2EFA-A4
					M20	D4GL-4EFA-A4
				2NC/1NO+2NC	Pg13.5	D4GL-1FFA-A4
					G1/2	D4GL-2FFA-A4
					M20	D4GL-4FFA-A4
			3NC+1NC/1NO	Pg13.5	D4GL-1GFA-A4	
				G1/2	D4GL-2GFA-A4	
				M20	D4GL-4GFA-A4	
			3NC+2NC	Pg13.5	D4GL-1HFA-A4	
				G1/2	D4GL-2HFA-A4	
				M20	D4GL-4HFA-A4	
			Solenoid lock Mechanical release	1NC/1NO+1NC/1NO	Pg13.5	D4GL-1AFG-A4
					G1/2	D4GL-2AFG-A4
					M20	D4GL-4AFG-A4
				1NC/1NO+2NC	Pg13.5	D4GL-1BFG-A4
					G1/2	D4GL-2BFG-A4
					M20	D4GL-4BFG-A4
				2NC+1NC/1NO	Pg13.5	D4GL-1CFG-A4
					G1/2	D4GL-2CFG-A4
					M20	D4GL-4CFG-A4
				2NC+2NC	Pg13.5	D4GL-1DFG-A4
					G1/2	D4GL-2DFG-A4
					M20	D4GL-4DFG-A4
2NC/1NO+1NC/1NO	Pg13.5	D4GL-1EFG-A4				
	G1/2	D4GL-2EFG-A4				
	M20	D4GL-4EFG-A4				
2NC/1NO+2NC	Pg13.5	D4GL-1FFG-A4				
	G1/2	D4GL-2FFG-A4				
	M20	D4GL-4FFG-A4				
3NC+1NC/1NO	Pg13.5	D4GL-1GFG-A4				
	G1/2	D4GL-2GFG-A4				
	M20	D4GL-4GFG-A4				
3NC+2NC	Pg13.5	D4GL-1HFG-A4				
	G1/2	D4GL-2HFG-A4				
	M20	D4GL-4HFG-A4				

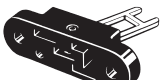
Operation Keys (Order Separately)

Type	Model
Horizontal mounting 	D4DS-K1
Vertical mounting 	D4DS-K2
Adjustable mounting (Horizontal) 	D4DS-K3
Adjustable mounting (Horizontal/Vertical) 	D4DS-K5

Specifications

Standards and EC Directives

Applicable EC Directives and Standards

- Machinery Directive
- Low Voltage Directive
- EN1088
- EN60204-1
- GS-ET-19

Approved Standards

Agency	Standard	File No.
TÜV Product Service	EN60947-5-1 (approved direct opening)	(See note 1.)
UL (See note 2.)	UL508, CSA C22.2 No.14	E76675

- Note:** 1. Consult your OMRON representative for details.
 2. Approval for CSA C22.2 No. 14 is authorized by the UL mark.

Approved Standard Ratings

TÜV (EN60947-5-1)

Item	Utilization category	AC-15	DC-13
Rated operating current (I_e)		0.75 A	0.27 A
Rated operating voltage (U_e)		240 V	250 V

Note: Use a 10-A fuse type gI or gG that conforms to IEC269 as a short-circuit protection device.

UL/CSA (UL508, CSA C22.2 No. 14)

C300

Rated voltage	Carry current	Current		Volt-amperes	
		Make	Break	Make	Break
120 VAC	2.5 A	15 A	1.5 A	1,800 VA	180 VA
240 VAC		7.5 A	0.75 A		

Q300

Rated voltage	Carry current	Current		Volt-amperes	
		Make	Break	Make	Break
125 VAC	2.5 A	0.55 A	0.55 A	69 VA	69 VA
250 VAC		0.27 A	0.27 A		

Solenoid Coil Characteristics

Item	24 VDC
Rated operating voltage (100% ED)	24 VDC \pm 10%
Current consumption	Approx. 200 mA
Insulation	Class F (130°C max.)

Indicator Characteristics

Item	LED
Rated voltage	24 VDC
Current leakage	Approx. 3 mA
Color (LED)	Orange/Green

Characteristics

Degree of protection (See note 2.)		IP67 (EN60947-5-1) (This applies for the Switch only. The degree of protection for the key hole is IP00.)	
Durability (See note 3.)	Mechanical	1,000,000 operations min.	
	Electrical	500,000 operations min. for a resistive load of 4 mA at 24 VDC; 150,000 operations min. for a resistive load of 1 A at 125 VAC in 2 circuits and 4 mA at 24 VDC in 2 circuits (See note 4.)	
Operating speed		0.05 to 0.5 m/s	
Operating frequency		30 operations/minute max.	
Rated frequency		50/60 Hz	
Contact gap		2 x 2 mm min.	
Direct opening force (See note 5.)		60 N min. (EN60947-5-1)	
Direct opening travel (See note 5.)		10 mm min. (EN60947-5-1)	
Holding force (See note 6.)		1,000 N min.	
Insulation resistance		100 MΩ min. (at 500 VDC)	
Minimum applicable load (See note 7.)		Resistive load of 4 mA at 24 VDC (N-level reference value)	
Rated insulation voltage (U)		300 V (EN60947-5-1)	
Conventional enclosed thermal current (I_{the})		2.5 A (EN60947-5-1)	
Impulse withstand voltage (EN60947-5-1)		Between terminals of the same polarity	2.5 kV
		Between terminals of different polarities	4 kV
		Between the solenoid and uncharged metallic parts and between the solenoid and ground	---
		24-VDC solenoid	0.8 kV
		Between other terminals and uncharged metallic parts and between other terminals and ground	4 kV
Conditional short-circuit current		100 A (EN60947-5-1)	
Pollution degree (operating environment)		3 (EN60947-5-1)	
Protection against electric shock		Class II (double insulation)	
Closed-circuit counterelectromotive force		1,500 V max. (EN60947-5-1)	
Contact resistance		25 mΩ max. (initial value)	
Vibration resistance	Malfunction	10 to 55 Hz, 0.75-mm single amplitude	
	Shock resistance		
	Destruction	1,000 m/s ² min.	
	Malfunction	300 m/s ² min.	
Ambient temperature		Operating: -10°C to 55°C with no icing	
Ambient humidity		Operating: 95% max.	
Weight		Approx. 400 g (D4GL-1AFA-A)	

- Note:**
- The above values are initial values.
 - The degree of protection is tested using the method specified by the standard (EN60947-5-1). Confirm that sealing properties are sufficient for the operating conditions and environment beforehand. Although the switch box is protected from dust or water penetration, do not use the D4GL in places where foreign material may penetrate through the key hole on the head, otherwise Switch damage or malfunctioning may occur.
 - The durability is for an ambient temperature of 5°C to 35°C and an ambient humidity of 40% to 70%. For more details, consult your OMRON representative.
 - If the ambient temperature is greater than 35°C, do not pass the 1-A, 125-VAC load through more than 2 circuits.
 - These figures are minimum requirements for safe operation.
 - This figure is based on the GS-ET-19 evaluation method.
 - This value will vary with the switching frequency, environment, and reliability level. Confirm that correct operation is possible with the actual load beforehand.

Connections

Indicator

Internal Circuit Diagram

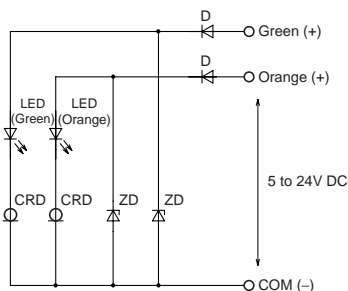

Circuit Connection Example

- Terminals 12 and 41 are connected internally and so connect terminals 11 and 42 for safety-circuit input. (BIA GS-ET-19)
- Connect terminals 21 and 22 and terminals 51 and 52 in series when using as safety-circuit input (redundancy circuit for terminals 11 and 12 and terminals 41 and 42 above). Connect the terminals individually when using as auxiliary-circuit input (e.g., terminals 21 and 22 for safety-door open/closed monitoring and terminals 51 and 52 for monitoring the lock status).
- In the following connection example, terminals 21 and 22 and terminals 51 and 52 are used as auxiliary-circuit input.

Connection Example for D4GL-1HFA-A

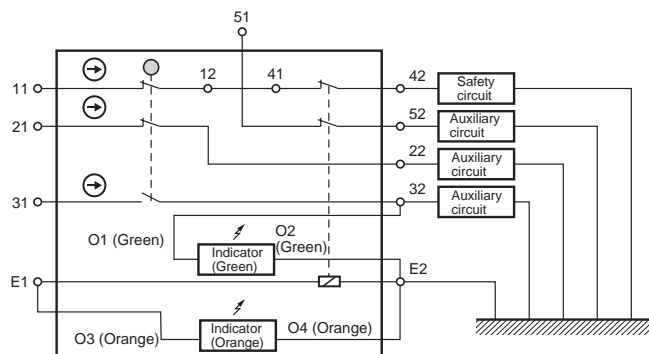

- Direct opening contacts used as safety-circuit input are indicated with the \ominus mark. Terminals 11 and 12 and terminals 21 and 22 are direct opening contacts.
- Connect the indicators in parallel to the auxiliary circuits or terminals E1 and E2.
- Although the 3 lines are connected at the time of delivery, rewire them as necessary for the application.
- The following table shows the connection configuration required to make the green indicator light when the door is closed and the orange indicator light when the solenoid turns ON.

Indicator	Terminal number	Lead wire color	Connected terminal number
Green indicator	O1	Green	32
Orange indicator	O2	Orange	E1
Common	O3	Black	E2

- If an indicator is connected in parallel to a direct opening contact, when the indicator breaks, a short-circuit current will be generated, possibly resulting in an installation malfunction.
- Do not switch standard loads for more than 2 circuits at the same time. Otherwise, the level of insulation may decrease.
- The solenoid has polarity. Be sure to connect terminals with the correct polarity.

D4GL

Operation Method

Operation Principles

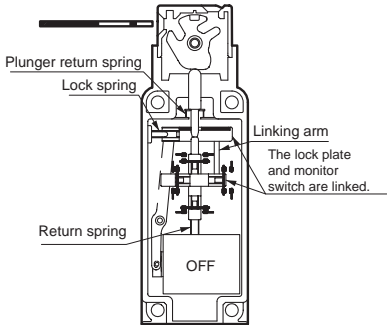
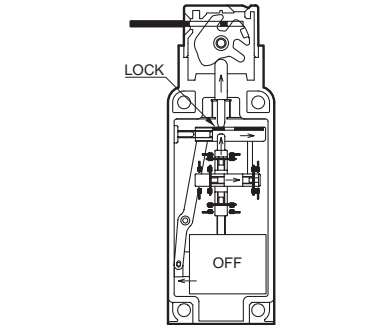
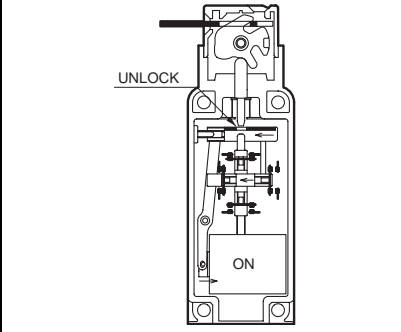
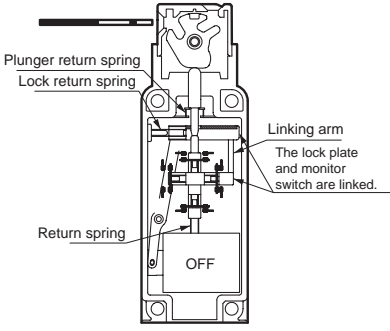
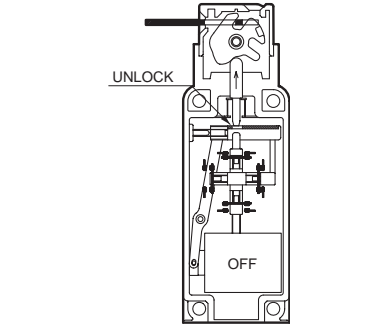
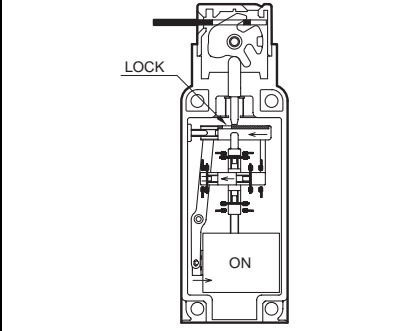
<p>Mechanical lock models</p>		 <p>When the door is closed, it is locked by the lock spring. The door will stay locked even if there is a power interruption.</p>	 <p>The solenoid is released only when the lock is turned ON.</p>
<p>Solenoid lock models</p>		 <p>If the solenoid is OFF, the door will not be locked when it is closed. This means that the door can be opened and closed easily when replacing workpieces or parts.</p>	 <p>The door is locked only when the solenoid is turned ON. This means that the door will be unlocked if there is a power interruption and so this model cannot be used in systems that would maintain a hazardous state (e.g., systems requiring toxic gases, high temperatures, or gears that would continue to turn due to inertia).</p>

Nomenclature

Structure

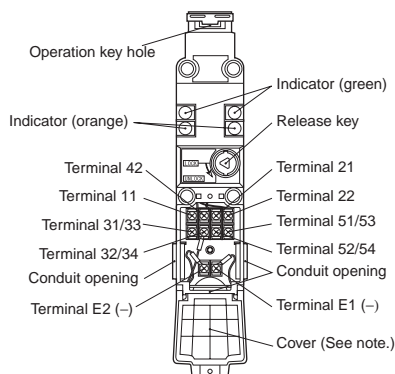

Note: Terminal numbers vary with the model. Confirm terminal numbers by referring to the cover on the back of the Switch.

Contact Form

Indicates conditions where the Key is inserted and the lock is applied. Terminals 12 and 41 are connected internally (as per BIA GS-ET-19).

Model	Contact	Contact form (door open/closed detection switch and lock monitor switch contacts)	Operating pattern	Remarks
D4GL-□AF□-□	1NC/1NO + 1NC/1NO			Only NC contact 11-12 has an approved direct opening mechanism. (→) The terminals 11-42, 33-34, and 53-54 can be used as unlike poles.
D4GL-□BF□-□	1NC/1NO + 2NC			Only NC contact 11-12, has an approved direct opening mechanism. (→) The terminals 11-42, 33-34, and 51-52 can be used as unlike poles.
D4GL-□CF□-□	2NC + 1NC/1NO			Only NC contacts 11-12 and 21-22 have an approved direct opening mechanism. (→) The terminals 11-42, 21-22, and 53-54 can be used as unlike poles.
D4GL-□DF□-□	2NC + 2NC			Only NC contacts 11-12 and 21-22 have an approved direct opening mechanism. (→) The terminals 11-42, 21-22, and 51-52 can be used as unlike poles.
D4GL-□EF□-□	2NC/1NO + 1NC/1NO			Only NC contacts 11-12 and 21-22 have an approved direct opening mechanism. (→) The terminals 11-42, 21-22, 33-34, and 53-54 can be used as unlike poles.
D4GL-□FF□-□	2NC/1NO + 2NC			Only NC contacts 11-12 and 21-22 have an approved direct opening mechanism. (→) The terminals 11-42, 21-22, 33-34, and 51-52 can be used as unlike poles.
D4GL-□GF□-□	3NC + 1NC/1NO			Only NC contacts 11-12, 21-22, and 31-32 have an approved direct opening mechanism. (→) The terminals 11-42, 21-22, 31-32, and 53-54 can be used as unlike poles.
D4GL-□HF□-□	3NC + 2NC			Only NC contacts 11-12, 21-22, and 31-32 have an approved direct opening mechanism. (→) The terminals 11-42, 21-22, 31-32, and 51-52 can be used as unlike poles.

D4GL

Dimensions

Note: All units are in millimeters unless otherwise indicated.

Switches

D4GL-□□□□-A

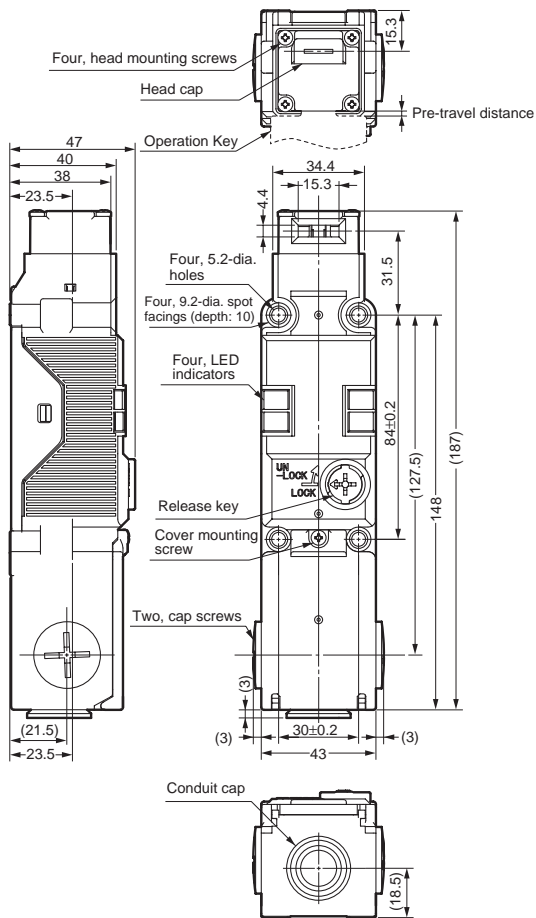

Operating characteristics	D4GL-□□□□-A
Key insertion force	15 N max.
Key extraction force	40 N max.
Pre-travel distance	10 mm max.
Movement before being locked	4 mm min.

D4GL-□□□□-A4

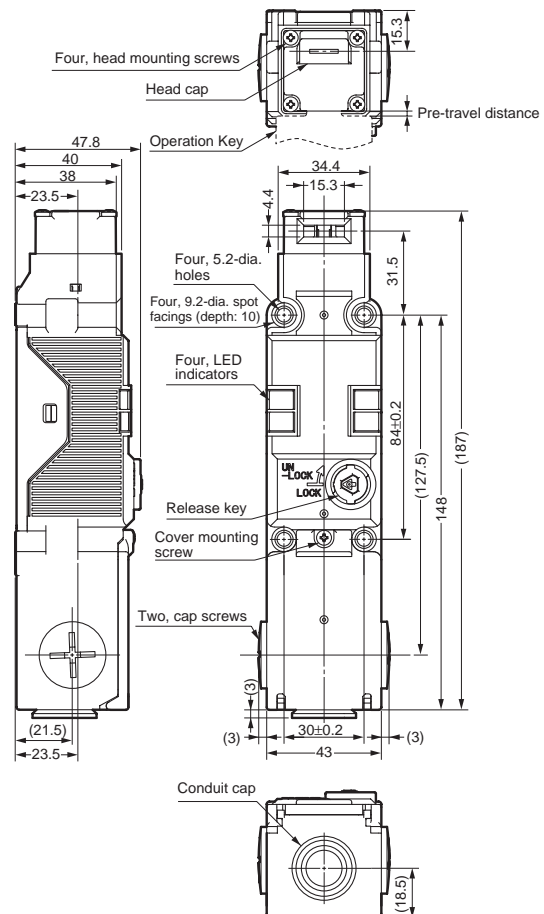

Operating characteristics	D4GL-□□□□-A4
Key insertion force	15 N max.
Key extraction force	40 N max.
Pre-travel distance	10 mm max.
Movement before being locked	4 mm min.

Operation Keys

Note: Unless otherwise specified, a tolerance of ± 0.4 mm applies to all dimensions.

D4DS-K1

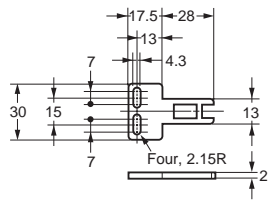
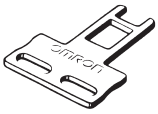

D4DS-K2

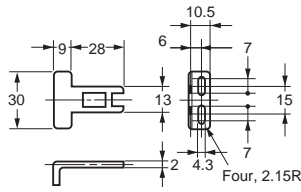
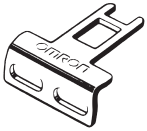

D4DS-K3

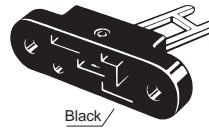

Black/

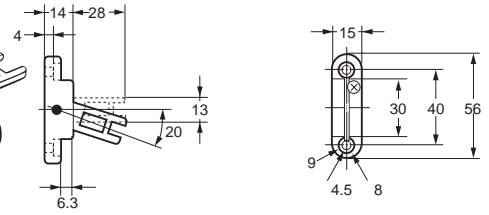

D4DS-K5

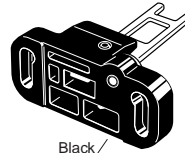

Black/

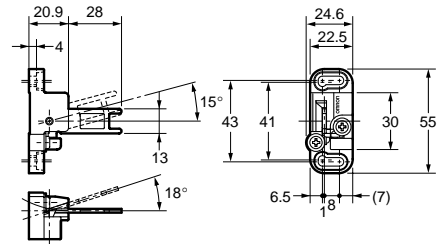

With Operation Key Inserted

D4GL + D4DS-K1

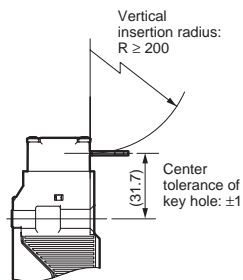
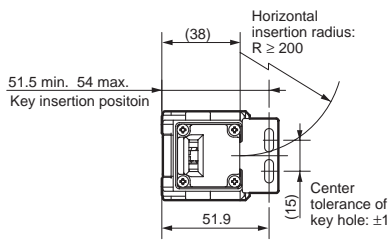

D4GL + D4DS-K2

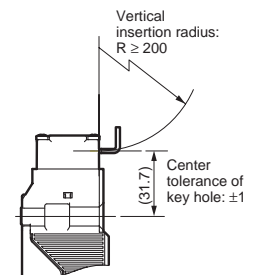
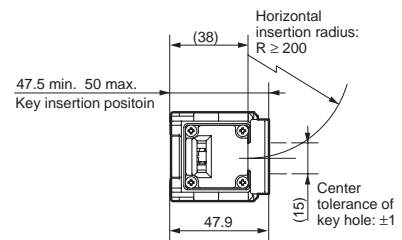

D4GL + D4DS-K3

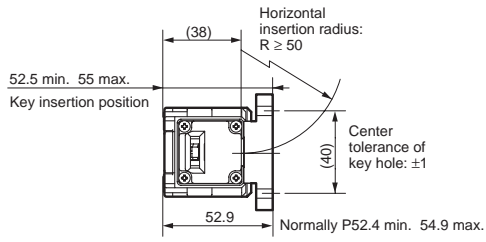

D4GL + D4DS-K5

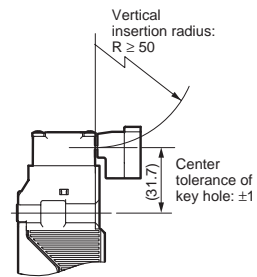
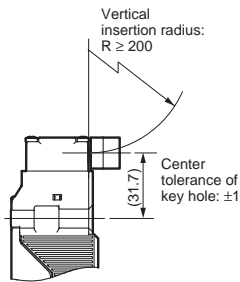
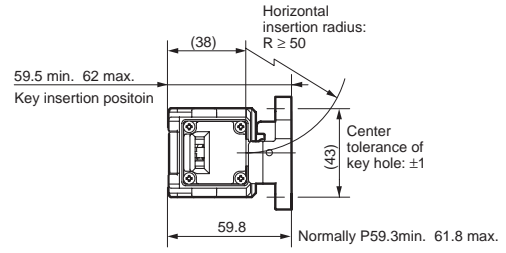

Application Examples

G9SA-321-T□ (24 VAC/VDC) + D4GL-□□□A-□ (Mechanical Lock Type)
+ D4D-□520N Circuit Diagram

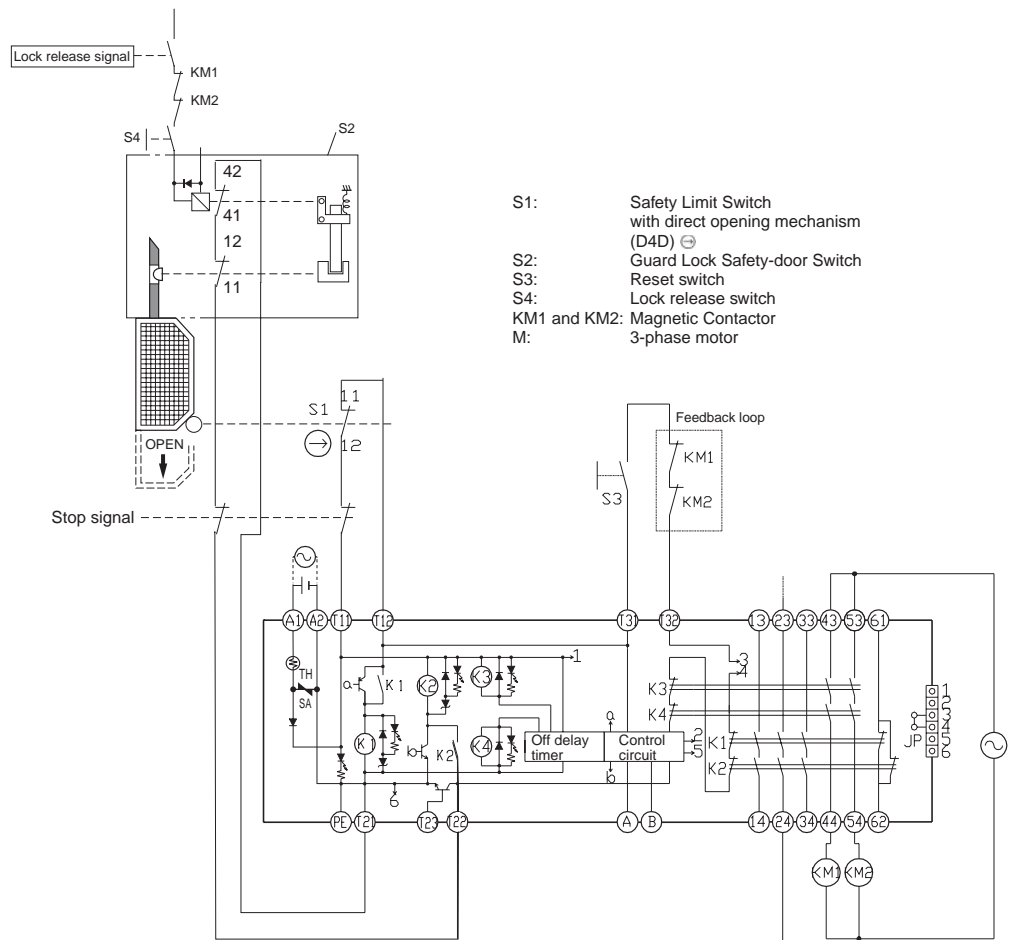

- S1: Safety Limit Switch with direct opening mechanism (D4D) ⊖
- S2: Guard Lock Safety-door Switch
- S3: Reset switch
- S4: Lock release switch
- KM1 and KM2: Magnetic Contactor
- M: 3-phase motor

Timing Chart

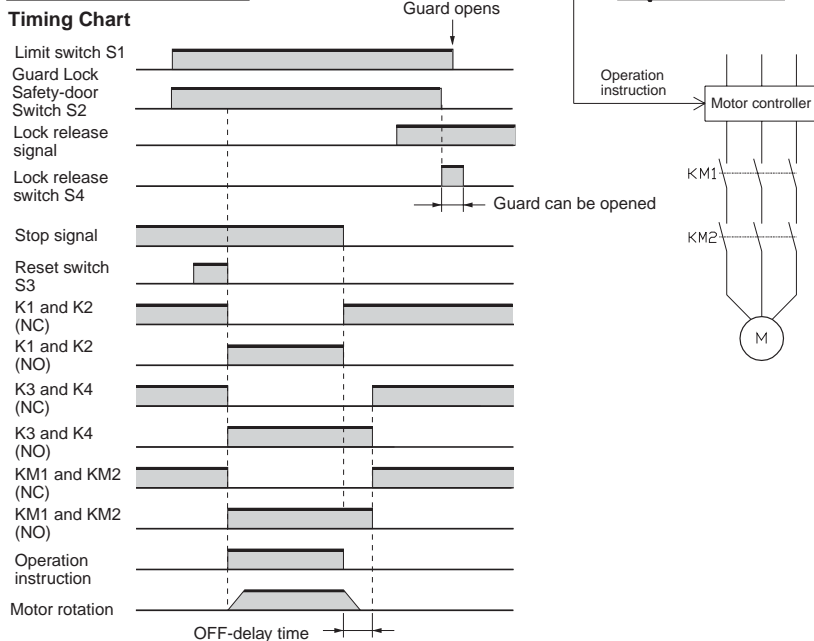

D4GL

G9SA-301 (24 VAC/VDC) + D4GL-□□□G-□ (Solenoid Lock Type)
 + D4D-□520N Circuit Diagram

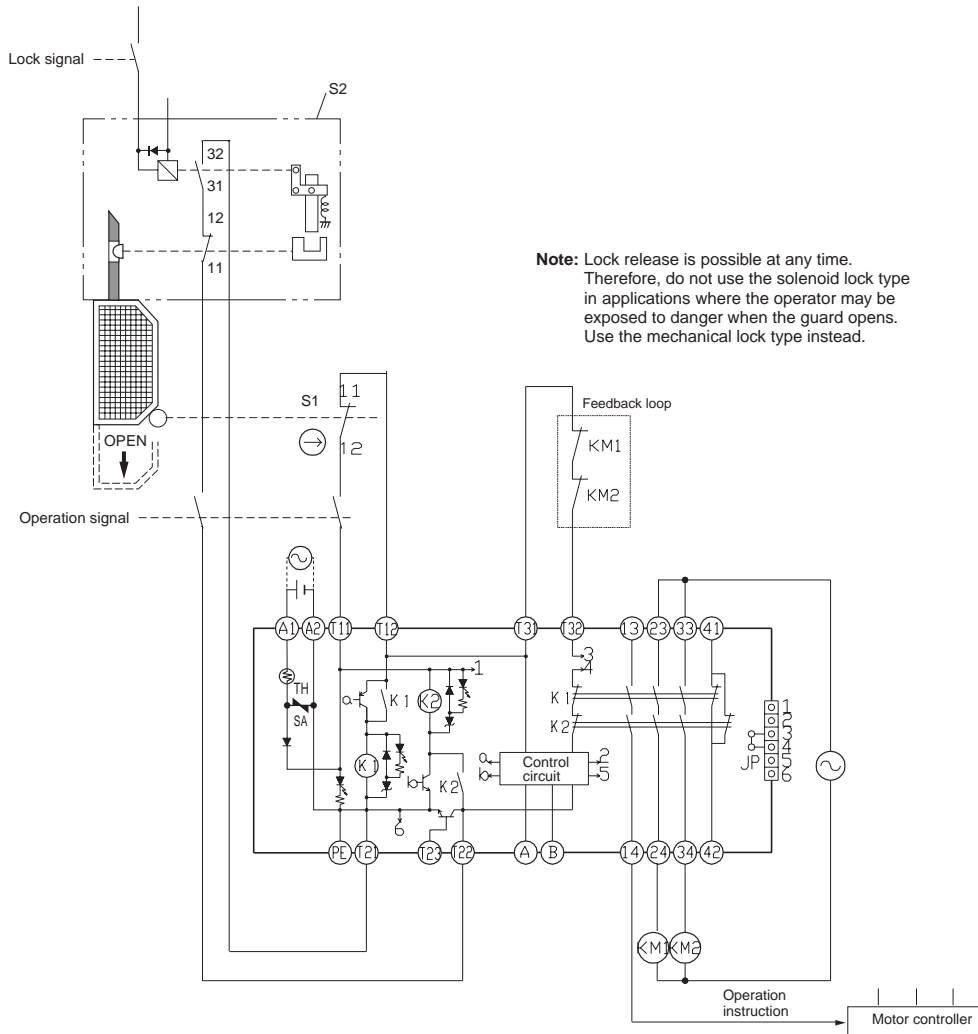

Note: Lock release is possible at any time.
 Therefore, do not use the solenoid lock type
 in applications where the operator may be
 exposed to danger when the guard opens.
 Use the mechanical lock type instead.

Timing Chart

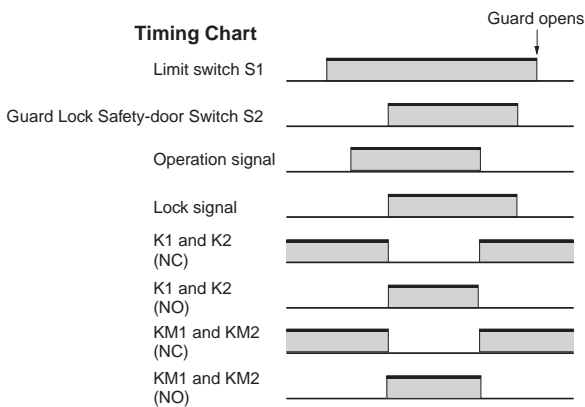

- S1: Safety Limit Switch with direct opening mechanism (D4D)
- S2: Guard Lock Safety-door Switch
- KM1 and KM2: Magnetic Contactor
- M: 3-phase motor

Precautions

⚠ Caution

Do not insert the Operation Key with the door open. The machine may operate and damage may result.

⚠ Caution

Do not use metal connectors or conduits with this switch. Damage to the broken conduit hole may cause electric shock.

⚠ Caution

Change the head direction after inserting the Operation Key or changing the release key to the UNLOCK position. Otherwise, the switch may malfunction and damage may result.

Holding Force

- Do not apply a force exceeding the specified holding force. Doing so may break the Switch and the machine may continue to operate.
- Either install another locking component (e.g., a stop) in addition to the Switch, or use a warning sticker or an indicator showing the lock status so that a force exceeding the specified holding force is not applied.

Safety Precautions

- Turn OFF the power before disassembling the Switch or touching any internal parts. Not doing so may result in electric shock.
- Mount the Operation Key in a location where it will not come in contact with users when the door is opened or closed. Otherwise, injury may result.
- Do not impose excessive force on the Operation Key when it is inserted into the Switch or drop the Switch with the Operation Key inserted. Otherwise, the Operation Key may be deformed or the Switch may be broken.
- Observe the specified insertion radius for the Operation Key and insert it in a direction perpendicular to the key hole.
- Do not use the Switch in starting circuits. (Use for safety confirmation signals.)
- When using the Switch in emergency-stop circuits or other safety circuits that have a direct impact on human lives, operate the NC contacts that have a direct opening mechanism in direct opening mode. For safety purposes, prevent easy removal by, for example, mounting the Switch and Operation Key with one-way screws or attaching a protective cover and warning label.
- In order to prevent short-circuit damage to the Switch, connect a fuse to the Switch in series. Use a fuse with a breaking current of 1.5 to 2 times the rated current. To conform to EN ratings, use a IEC269-compliant 10-A fuse type gI or gG.
- Turn the power OFF when wiring. After wiring is completed, be sure to mount the cover before use.
- In order to prevent burning due to overvoltage, insert a protective fuse in the solenoid circuits.
- Do not use the Switch where explosive gas, flammable gas, or any other dangerous gas may be present.
- Ensure that the load current does not exceed the rated current.
- Be sure to wire the terminals correctly.
- Be sure to evaluate the Switch under actual operating conditions after installation.
- Do not drop the package or the product. Do not disassemble internal parts.

Release Key

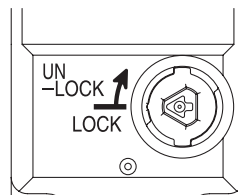

- The release key is used to unlock the Switch in case of emergency or if the power supply to the Switch stops.
- If the release key setting is changed from LOCK to UNLOCK using an appropriate tool, the lock will be released and the safety door can be opened (mechanical lock models only).
- After setting the release key to UNLOCK in order to, for example, change the head direction or perform maintenance, be sure to return it to LOCK setting before resuming operation.
- When the Switch is used for the door of a machine room to ensure the safety of people performing adjustment work inside, if the release key is set to UNLOCK, the door will not be locked when the door is closed and no power will be supplied to the equipment.
- Do not use the release key to start or stop machines.
- The auxiliary lock must only be released by authorized personnel.
- Do not impose excessive force on the release key screws. The release key may be damaged and may not operated properly.
- To prevent easy release of the auxiliary lock by unauthorized personnel, set it to LOCK and seal it with seal wax.

Mounting

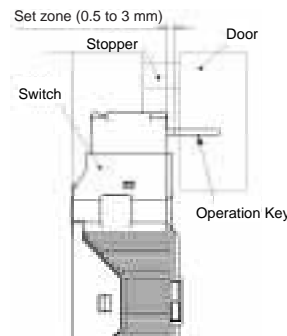

- Do not use the Switch as a stopper. To prevent the door from coming into contact with the flange of the Operation Key, be sure to mount the Switch with a stopper as shown above.
- When the Switch is used for a hinged door at a location near to the hinged side, where the Operation Key's insertion radius is comparatively small, if an attempt is made to open the door beyond the lock position, the force imposed will be much larger than for locations far from the hinged side, and the lock may be damaged.

Solenoid Lock Models

The solenoid lock locks the door only when power is supplied to the solenoid. Therefore, the door will be unlocked if the power supply to the solenoid stops. Therefore, do not use solenoid lock models for machines that may be operating and dangerous even after the machine stops operating.

Correct Use

Operating Environment

- This Switch is for indoor use only. Do not use it outdoors. Otherwise, it may malfunction.
- Do not use the Switch in the following locations:
 - Locations subject to severe temperature changes
 - Locations subject to high humidity levels or condensation
 - Locations subject to severe vibration
 - Locations where the Switch may come in contact with metal dust, oil, or chemicals
 - Locations subject to thinner, detergent, or other solvents
- Although the switch itself is protected from dust or water penetration, ensure that foreign material does not penetrate through the key hole on the head, otherwise Switch damage or malfunctioning may occur.
- Do not use the Switch submerged in oil or water, or in locations continuously subject to splashes of oil or water. Doing so may result in oil or water entering the Switch interior. (The IP67 degree of protection specification for the Switch pertains to the amount of water penetration after the Switch is submerged in water for a certain period of time.)

Life Expectancy

The life expectancy of the Switch will vary with the switching conditions. Before applying the Switch, test it under actual operating conditions and be sure to use it at a switching frequency that will not lower its performance.

Mounting

Tightening Torque

Be sure to tighten each screw of the Switch properly. Loose screws may result in malfunction.

Terminal screw	0.4 to 0.5 N·m
Cover mounting screw	0.5 to 0.7 N·m
Head mounting screw	0.5 to 0.6 N·m
Operation Key mounting screw	2.4 to 2.8 N·m
Switch mounting screw	1.3 to 1.5 N·m
Connector	1.8 to 2.1 N·m
Cap screw	1.3 to 1.7 N·m

Switch and Operation Key Mounting

- Mount the Switch and Operation Key securely to the applicable tightening torque with M5 screws.

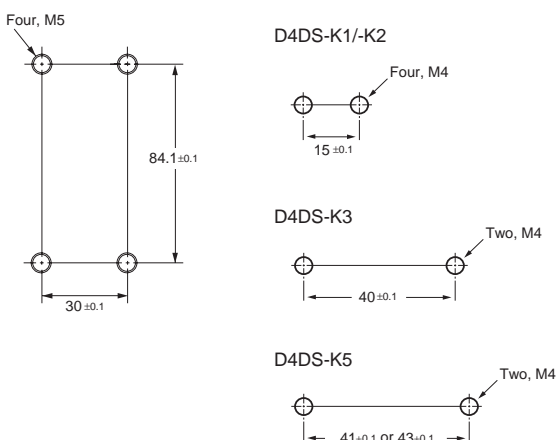

- Use the designated OMRON Operation Key with the Switch. Using another Operation Key may result in Switch damage.
- Ensure that the alignment offset between the Operation Key and the key hole does not exceed ± 1 mm.

Head Direction

By removing the four screws of the head, the mounting direction of the head can be changed. The head can be mounted in four directions.

Ensure that no foreign matter penetrates the interior of the Switch. Also, insert the head until the insertion line engraved on the head is hidden by the reference line on the Switch, as shown in the following diagram.

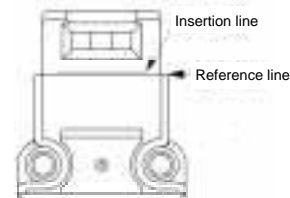

Securing the Door

When the door is closed (with the Operation Key inserted), it may be pulled beyond the set zone because of, for example, the door's weight, or the door cushion rubber. Also, if a load is applied to the Operation Key, the door may fail to unlock properly. Use hooks to ensure that the door stays within the set zone.

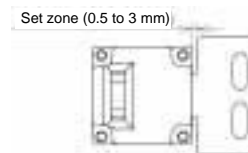

Wiring

Wiring Precautions

- Applicable lead wire size: AWG22 to AWG24.
- When connecting lead wires directly to terminals, perform wiring securely so that there are no loose wire strands.
- Do not push crimp terminals into gaps in the case interior. Doing so may cause damage or deformation of the case.
- Use lead wires of an appropriate length. Not doing so may cause the cover to rise.
- Use crimp terminals not more than 0.5 mm in thickness. Otherwise, they will interfere with other components inside the case.

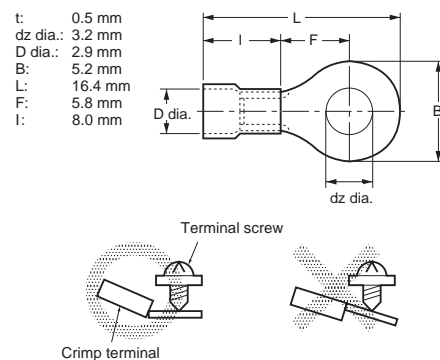

Circuit Connection Example

- Terminals 12 and 41 are connected internally and so connect terminals 11 and 42 for safety-circuit input. (BIA GS-ET-19)
- Connect terminals 21 and 22 and terminals 51 and 52 in series when using as safety-circuit input (redundancy circuit for terminals 11 and 12 and terminals 41 and 42 above). Connect the terminals individually when using as auxiliary-circuit input (e.g., terminals 21 and 22 for safety-door open/closed monitoring and terminals 51 and 52 for monitoring the lock status).
- In the following connection example, terminals 21 and 22 and terminals 51 and 52 are used as auxiliary-circuit input.

Connection Example for D4GL-1HFA-A

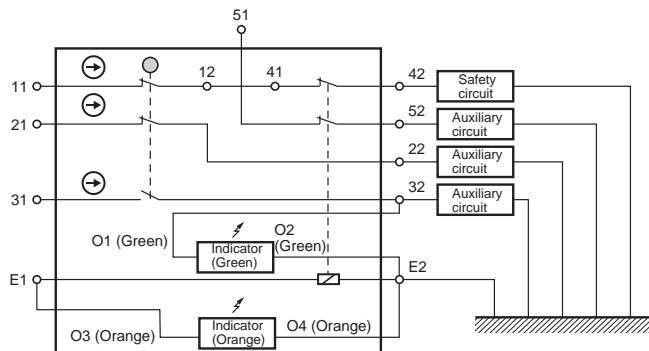

- Direct opening contacts used as safety-circuit input are indicated with the ⊖ mark. Terminals 11 and 12, terminals 21 and 22, and terminals 31 and 32 are direct opening contacts.
- Connect the indicators in parallel to the auxiliary circuits or terminals E1 and E2.
- Although the 3 lines are connected at the time of delivery, rewire them as necessary for the application.
- The following table shows the connection configuration required to make the green indicator light when the door is closed and the orange indicator light when the solenoid turns ON.

Indicator	Terminal number	Lead wire color	Connected terminal number
Green indicator	O1	Green	32
Orange indicator	O2	Orange	E1
Common	O3	Black	E2

- If an indicator is connected in parallel to a direct opening contact, when the indicator breaks, a short-circuit current will be generated, possibly resulting in an installation malfunction.
- Do not switch standard loads for more than 2 circuits at the same time. Otherwise, the level of insulation may decrease.
- The solenoid has polarity. Be sure to connect terminals with the correct polarity.

Conduit Opening

- Connect a recommended connector to the opening of the conduit and tighten the connector to the proper torque. The case may be damaged if an excessive tightening torque is applied.
- In order to ensure IP67 degree of protection, wrap sealing tape around the conduit end of the connector.
- Be sure that the outer diameter of the cable connected to the connector is correct.
- Attach and tighten a conduit cap to the unused conduit opening when wiring. The conduit cap is provided with the Switch.

Recommended Connectors

Use a connector with a screw section not exceeding 10 mm, otherwise the screws will protrude into the case interior. The connectors given in the following table have connectors with screw sections not exceeding 10 mm.

Size	Manufacturer	Model	Applicable cable diameter
G1/2	LAPP	ST-PF1/2 5380-1002	6.0 to 12.0 mm
	OHM ELECTRIC CO.	OA-W1609	7.0 to 9.0 mm
OA-W1611		9.0 to 11.0 mm	
Pg13.5	LAPP	S-13.5 5301-5030	5.0 to 12.0 mm
M20	LAPP	ST-M20 *1.5 5311-1020	7.0 to 13.0 mm

Use LAPP connectors together with seal packing (JPK-16, GP-13.5, or GPM20), and tighten with the applicable torque. Seal packing is sold separately.

Maintenance and Repairs

The user must not perform repairs or maintenance. Contact the machine manufacturer if repairs or maintenance are required.

Storage

Do not store the Switch in locations where harmful gases (e.g., H₂S, SO₂, NH₃, HNO₃, or Cl₂) or dust are present, or in locations subject to high humidity levels.

Miscellaneous

- In conditions requiring greater rigidity, sealing performance, and oil resistance, use OMRON's D4BL.
- Perform regular inspections.

D4GL