

Reflective

- Phototransistor output.
- Optimum sensing distance 4.4mm.
- Incorporates combined dust cover and filter to reduce effect of external visible light.

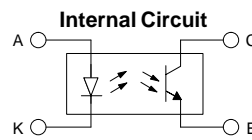

Dimensions

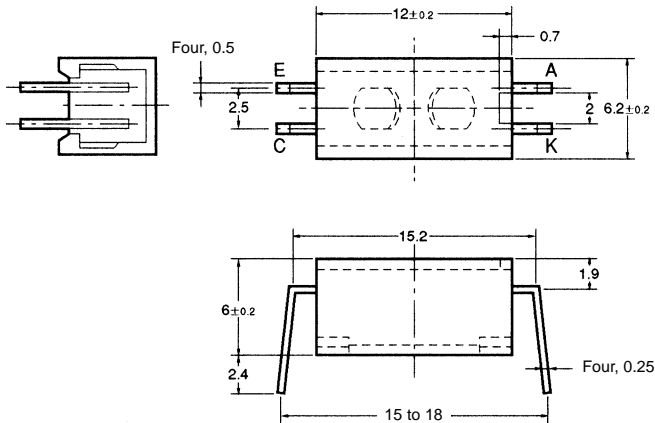

Terminal No.	Name
A	Anode
K	Cathode
C	Collector
E	Emitter

Unless otherwise specified, the tolerances are as shown below.

Dimensions	Tolerance
3 mm max.	±0.3
3 < mm ≤ 6	±0.375
6 < mm ≤ 10	±0.45
10 < mm ≤ 18	±0.55
18 < mm ≤ 30	±0.65

■ Absolute Maximum Ratings (Ta = 25°C)

Item	Symbol	Rated value
Emitter	Forward current	I_F
	Pulse forward current	I_{FP}
	Reverse voltage	V_R
Detector	Collector-Emitter voltage	V_{CEO}
	Emitter-Collector voltage	V_{ECO}
	Collector current	I_C
	Collector dissipation	P_C
Ambient temperature	Operating	T_{opr}
	Storage	T_{stg}
	Soldering	T_{sol}

- Note:**
1. Refer to the temperature rating chart if the ambient temperature exceeds 25°C.
 2. The pulse width is 10 μ s maximum with a frequency of 100 Hz.

■ Electrical and Optical Characteristics (Ta = 25°C)

Item		Symbol	Value	Condition
Emitter	Forward voltage	V_F	1.2 V typ., 1.5 V max.	$I_F = 30$ mA
	Reverse current	I_R	0.01 μ A typ., 10 μ A max.	$V_R = 4$ V
	Peak emission wavelength	λ_P	940 nm typ.	$I_F = 20$ mA
Detector	Light current	I_L	160 μ A min., 1,600 μ A max.	$I_F = 20$ mA, $V_{CE} = 10$ V White paper with a reflection ratio of 90%, $d = 4.4$ mm (see note)
	Dark current	I_D	2 nA typ., 200 nA max.	$V_{CE} = 10$ V, 0 lx
	Leakage current	I_{LEAK}	2 μ A max.	$I_F = 20$ mA, $V_{CE} = 10$ V with no reflection
	Collector–Emitter saturated voltage	$V_{CE}(\text{sat})$	---	---
	Peak spectral sensitivity wavelength	λ_P	850 nm typ.	$V_{CE} = 10$ V
Rising time		t_r	30 μ s typ.	$V_{CC} = 5$ V, $R_L = 1$ k Ω , $I_L = 1$ mA
Falling time		t_f	30 μ s typ.	$V_{CC} = 5$ V, $R_L = 1$ k Ω , $I_L = 1$ mA

Note: The letter “d” indicates the distance between the top surface of the sensor and the sensing object.

Engineering Data

Forward Current vs. Collector Dissipation Temperature Rating

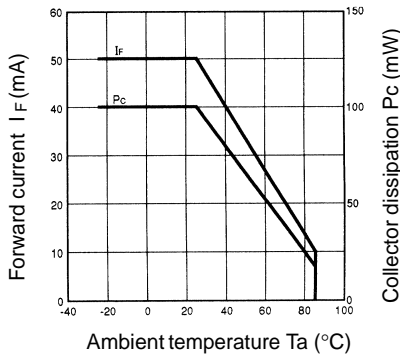

Light Current vs. Forward Current Characteristics (Typical)

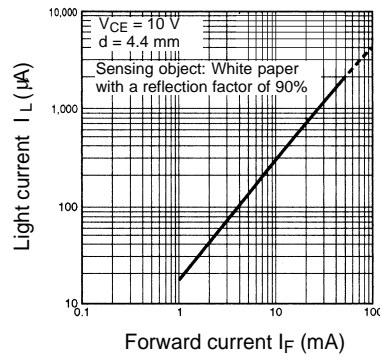

Light Current vs. Collector–Emitter Voltage Characteristics (Typical)

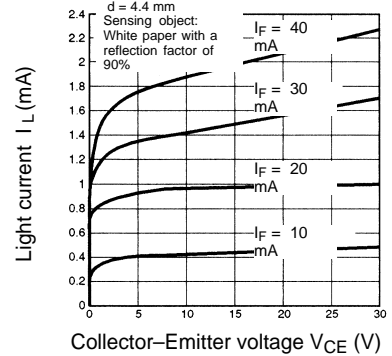

Relative Light Current vs. Ambient Temperature Characteristics (Typical)

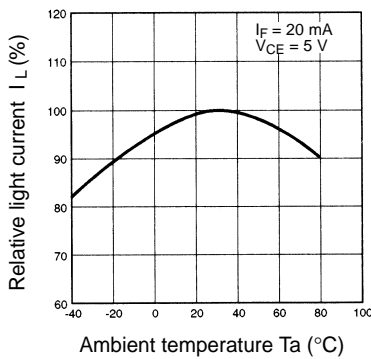

Dark Current vs. Ambient Temperature Characteristics (Typical)

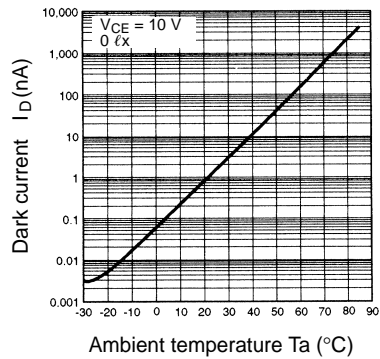

Response Time vs. Load Resistance Characteristics (Typical)

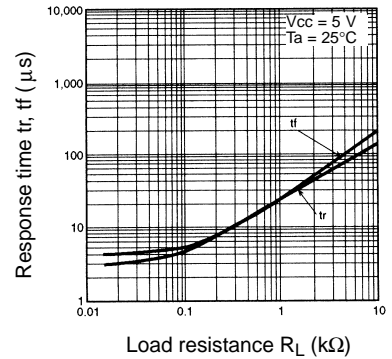

Sensing Distance Characteristics (Typical)

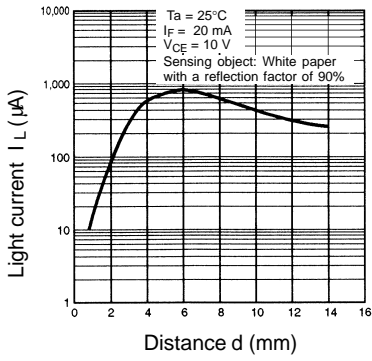

Sensing Position Characteristics (Typical)

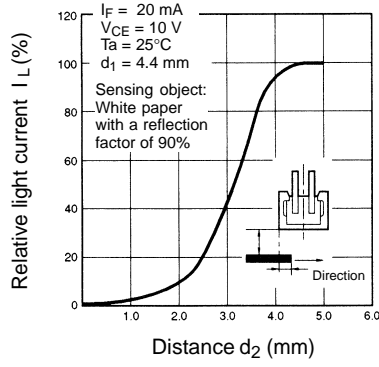

Sensing Angle Characteristics (Typical)

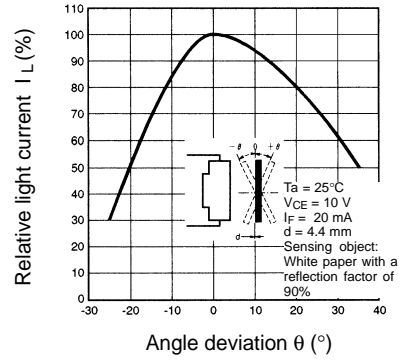

Response Time Measurement Circuit

