

### Transmissive

- Photo-Darlington output.
- General-purpose model with a 3-mm-wide slot.
- PCB mounting type.
- High resolution with a 0.5-mm-wide aperture.
- Best suited to drive CMOS IC.

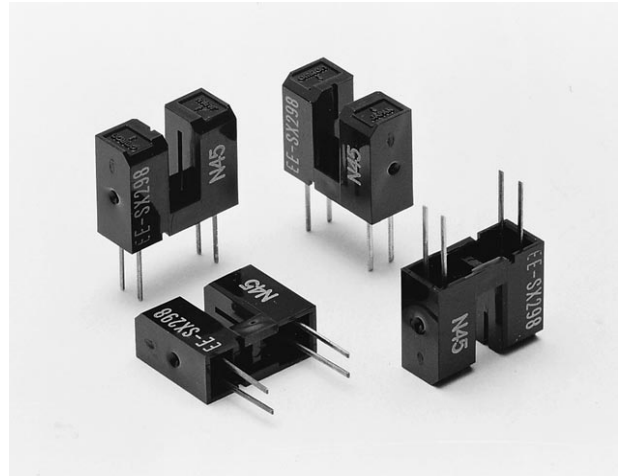

### Dimensions

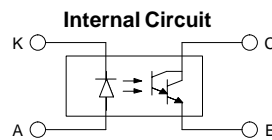
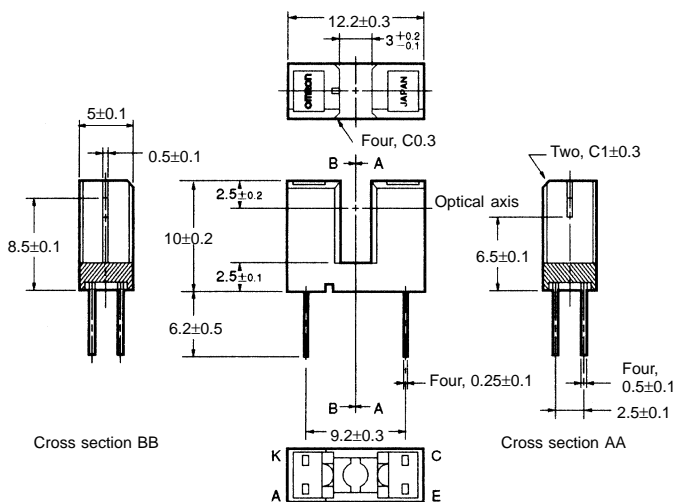

Terminal No.	Name
A	Anode
K	Cathode
C	Collector
E	Emitter

Unless otherwise specified, the tolerances are  $\pm 0.2$ .

### Specifications

#### ■ Absolute Maximum Ratings ( $T_a = 25^\circ\text{C}$ )

Item	Symbol	Rated value
Emitter	Forward current	$I_F$
	Pulse forward current	$I_{FP}$
	Reverse voltage	$V_R$
Detector	Collector-Emitter voltage	$V_{CEO}$
	Emitter-Collector voltage	$V_{ECO}$
	Collector current	$I_C$
	Collector dissipation	$P_C$
Ambient temperature	Operating	$T_{opr}$
	Storage	$T_{stg}$
	Soldering	$T_{sol}$

- Note:**
1. Refer to the temperature rating chart if the ambient temperature exceeds  $25^\circ\text{C}$ .
  2. The pulse width is 10  $\mu\text{s}$  maximum with a frequency of 100 Hz.

## Electrical and Optical Characteristics (Ta = 25°C)

Item		Symbol	Value	Condition
Emitter	Forward voltage	$V_F$	1.2 V typ., 1.4 V max.	$I_F = 20$ mA
	Reverse current	$I_R$	0.01 $\mu$ A typ., 10 $\mu$ A max.	$V_R = 4$ V
	Peak emission wavelength	$\lambda_P$	940 nm typ.	$I_F = 20$ mA
Detector	Light current	$I_L$	0.5 mA min., 20 mA max.	$I_F = 1$ mA, $V_{CE} = 2$ V
	Dark current	$I_D$	2 nA typ., 1,000 nA max.	$V_{CE} = 10$ V, 0 lx
	Leakage current	$I_{LEAK}$	---	---
	Collector–Emitter saturated voltage	$V_{CE(sat)}$	0.75 V typ., 1.0 V max.	$I_F = 2$ mA, $I_L = 0.5$ mA
	Peak spectral sensitivity wavelength	$\lambda_P$	780 nm typ.	$V_{CE} = 5$ V
Rising time		$t_r$	70 $\mu$ s typ.	$V_{CC} = 5$ V, $R_L = 100 \Omega$ , $I_L = 10$ mA
Falling time		$t_f$	70 $\mu$ s typ.	$V_{CC} = 5$ V, $R_L = 100 \Omega$ , $I_L = 10$ mA

## Engineering Data

**Forward Current vs. Collector Dissipation Temperature Rating**

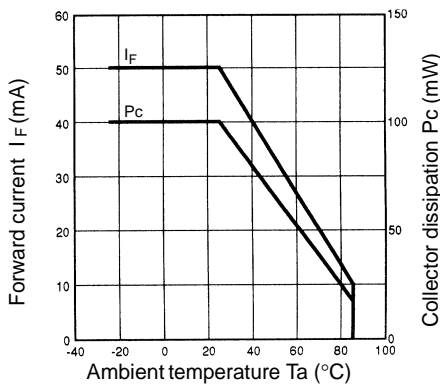

**Forward Current vs. Forward Voltage Characteristics (Typical)**

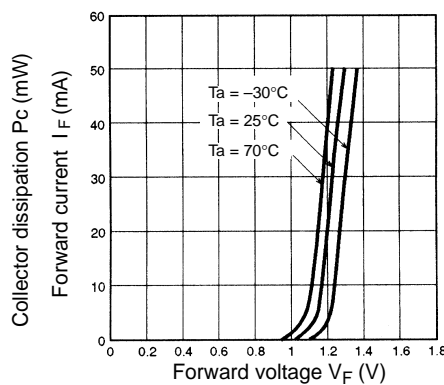

**Light Current vs. Forward Current Characteristics (Typical)**

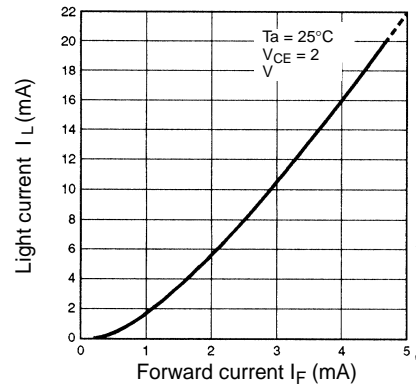

**Light Current vs. Collector–Emitter Voltage Characteristics (Typical)**

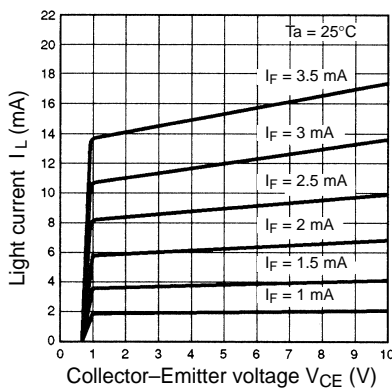

**Relative Light Current vs. Ambient Temperature Characteristics (Typical)**

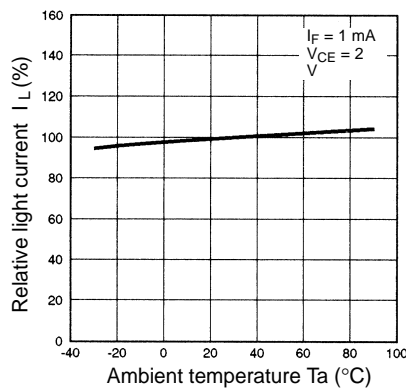

**Dark Current vs. Ambient Temperature Characteristics (Typical)**

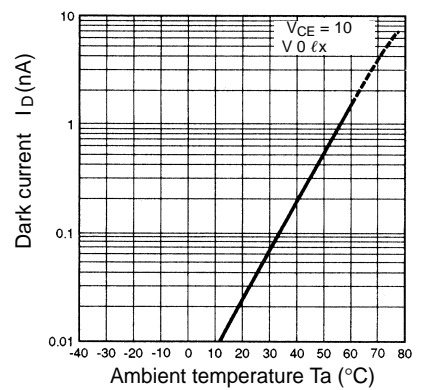

**Response Time vs. Load Resistance Characteristics (Typical)**

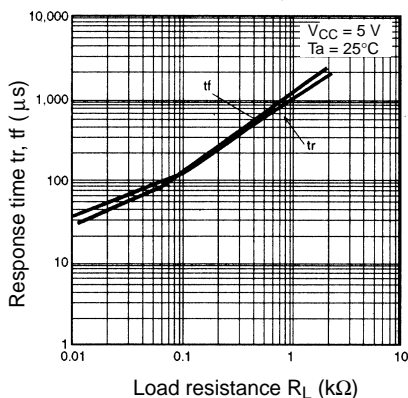

**Sensing Position Characteristics (Typical)**

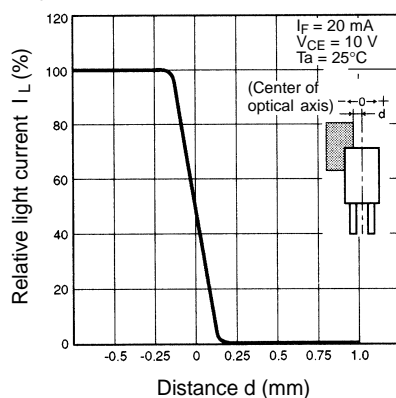

**Response Time Measurement Circuit**

